

# FIXING OPTIONS - TYPE 200 FLOOR SUPPORTED

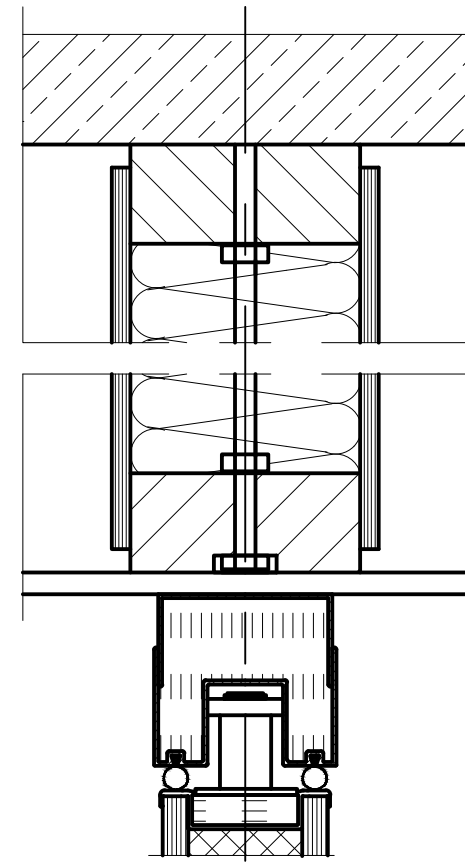

## VERTICAL SECTION - TOP GUIDE CHANNEL

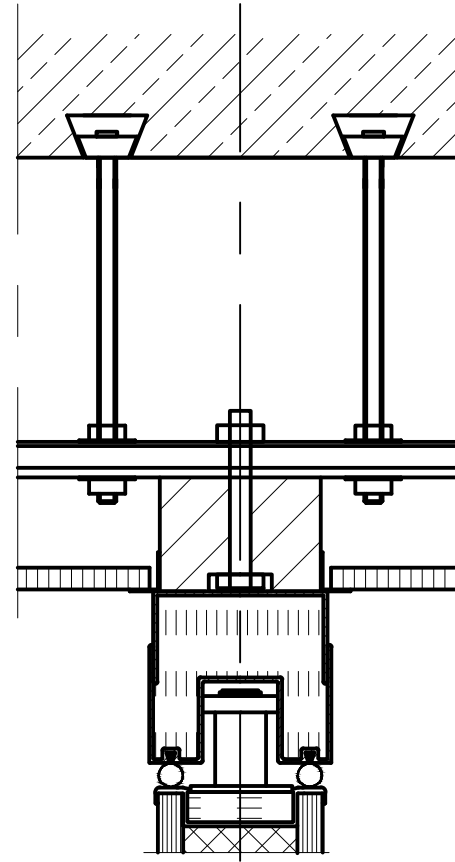
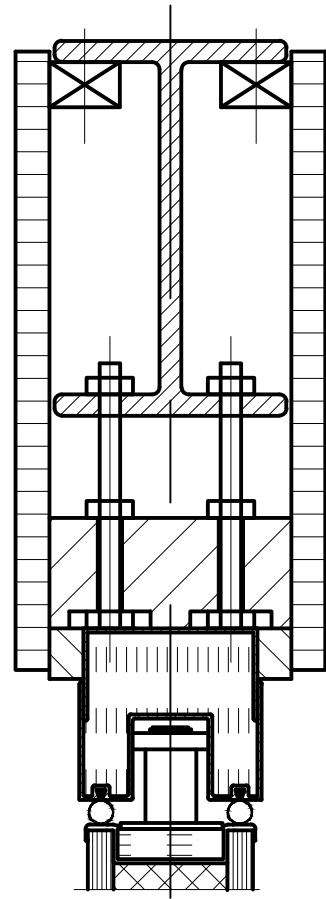
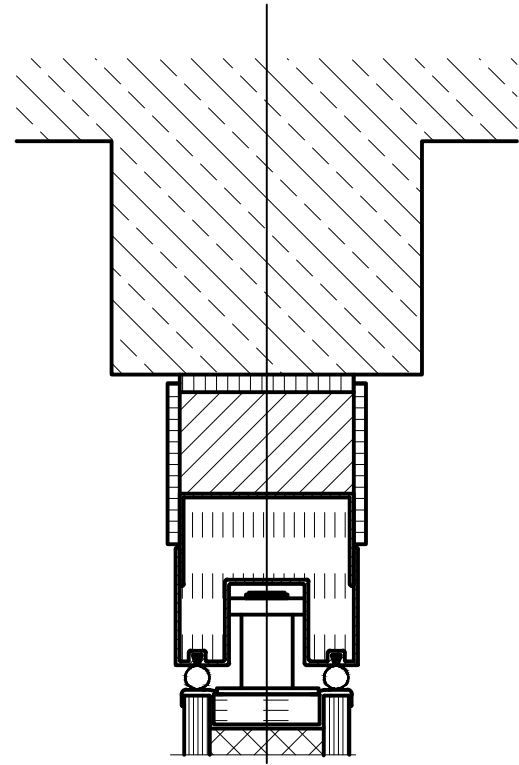
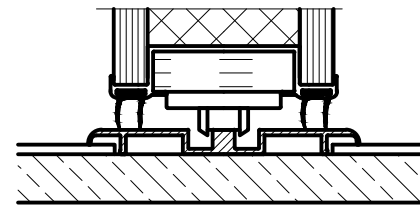
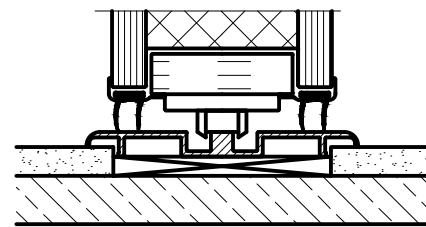
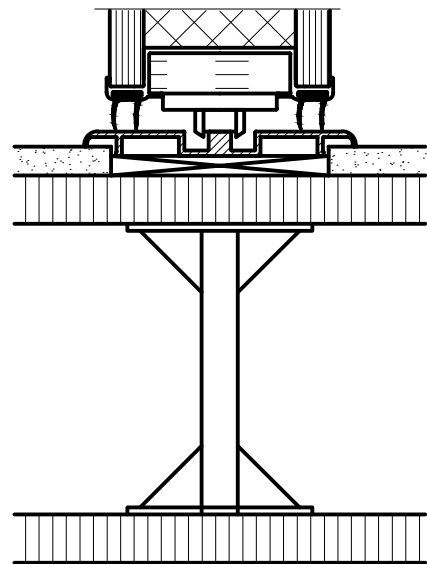

CARPET UNDERLAY  
> 4mm

PVC OR CARPET  
TILE +/- 4mm

NB : RAISED FLOOR  
PEDESTALS REQUIRED  
ON PARTITION  $\phi$

## VERTICAL SECTION - FLOOR BOTTOM RAIL

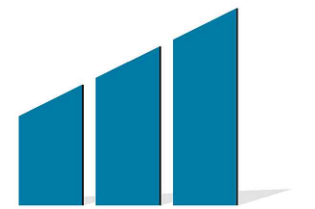

MOVAWALL  
Movawall Systems Ltd

Tel : +44 (0) 20 8391 8790

[www.movawall.co.uk](http://www.movawall.co.uk)

E-Mail : [Sales@movawall.co.uk](mailto:Sales@movawall.co.uk)

DRG. NO.: SL - 202